



Family

Basi

We simply classify the Basi family of luminaires as follows - they have perfect light parameters and contain special sources. The high brightness of the LED with color rendering of $Ra > 80$ or $Ra > 90$ perfectly illuminates the required object. That's why Basi can be used mainly in shopping centers, store-front windows, cultural spaces or car shows.

Type of installation	Recessed
Light distribution	Direct
Colour of the luminaires	Black, Silver, White
Colour Temperature	3000 K warm white, 4000 K cool white, 2700 K - 6500 K Tunable White, 3500 K neutral white, Meat, Bakery products, Fruit, Silver
Material	Sheet metal
Light source	LED MODUL
LED type	Strong Colour, Real Colour, Real White, Tunable White
MacAdam Light source	3
Connection of the luminaires	ON/OFF DALI Tunable white
Lifetime	L80/B20, L80/B10 50 000 hours
Warranty	60 months

Luminaire family variants Basi

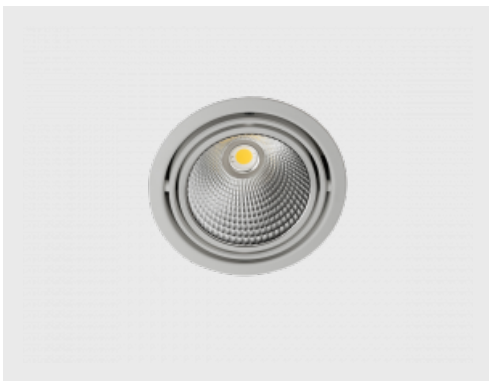

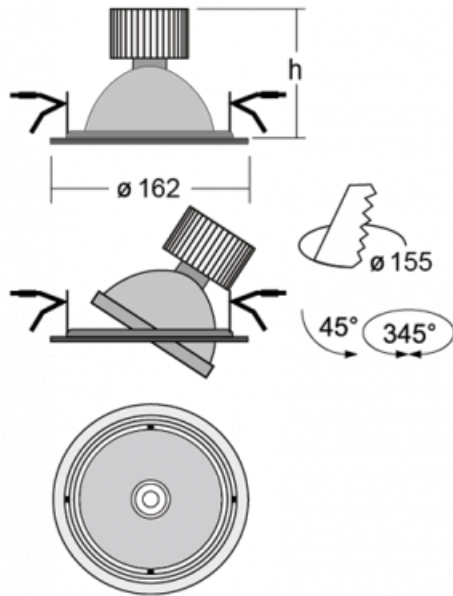
Basi

Assembly

Light distribution

Energy class

A++, A+, A

Marks

Code	Dimensions l/w/h (mm)	Power of the luminaire (W)	Luminous flux (lm)	Colour Temperature (K)	UGR
70-003F-10GDE/840, W	∅ 162 × 90	9.7	1280	4000	< 13.6
70-003F-10GGE/840, W	∅ 162 × 90	15.2	1990	4000	< 15.1
70-003F-10GHE/840, W	∅ 162 × 90	23.6	2870	4000	< 16.4
70-003F-10GIE/840, W	∅ 162 × 110	37.2	4090	4000	< 17.6
70-003F-10GJE/840, W	∅ 162 × 110	41.7	4750	4000	< 18.1









The indicated codes stand for a white luminaire with colour temperature of 4000K and with a medium-wide beam angle.

Notes	Beam angle	24 - 62 °
	Colour of the luminaires	
	Colour Temperature	3000 K warm white 4000 K cool white 2700 K - 6500 K Tunable White 3500 K neutral white Meat Bakery products Fruit Silver
	Optic system	Reflector
	Connection of the luminaires	ON/OFF DALI Tunable white
	Ra	65 80 90 95 97



Luminaires come complete with all necessary accessories.

Legend





Type of installation

 Recessed lights	 Wall mounted lights
 Semi-recessed luminaire	 Suspended lights
 Surface lights	 Free-standing lights
 3 circuit track lights	 Table lamp lights





Light distribution

 Direct luminaire
 Direct-indirect luminaire
 Indirect luminaire

Light source

 Tunable White adjusting the color temperature	 RealWhite true display of white color
 RealColour true display of colors Ra≥97	 StrongColour highlight one color

Marks

 Luminaire of electrical classification I (accessible conductive parts are connected to a protective cable)
 Luminaire of electrical classification II (accessible conductive parts are connected to a protective cable)
 Luminaire of electrical classification III (protection against electric shock is based on double or reinforced insulation)
 European mark of conformity that indicates the conformity of the properties of the product with all the harmonized standards and regulations of the European Community that apply to it
 Luminaires are certified according to the European ENEC system

 Recommended mounting hole size

IPxy IP code indicating the degree of protection of live parts

ERC Eurasian Conformity

09-501I-20GGE/840, W

09-501I-20GGE/840, W

09-501I-20GGE/840, W

09-501I-20GGE/840, W

Optic system

Electrical connection

Colour









Optic system

C Clear cover	L Plain aluminium reflector
D Asymmetric reflector	M Matt parabolic louvre
E Polished parabolic louvre, high LOR	S SPOT - narrow angle
F FLOOD - wide angle	U MEDIUM - middle angle
I Microprismatic optical system	W Wide beam angle
K Opal diffuser	

Electrical connection

D DALI dimmable	P Sensor and electronic ballast
E Electronic ballast non-dimmable	T By switch dimmable (touch dimm)
M Electronic ballast non-dimmable with 1h emergency	TD DALI or by switch (touch dimm) dimmable
M3 Electronic ballast non-dimmable with 3h emergency	U Dimmable luminaire with dimmer on the luminaire

Colour

W  White	B  Black	S  Silver
1021  RAL 1021	3000  RAL 3000	6021  RAL 6021
7006  RAL 7006	7045  RAL 7045	