

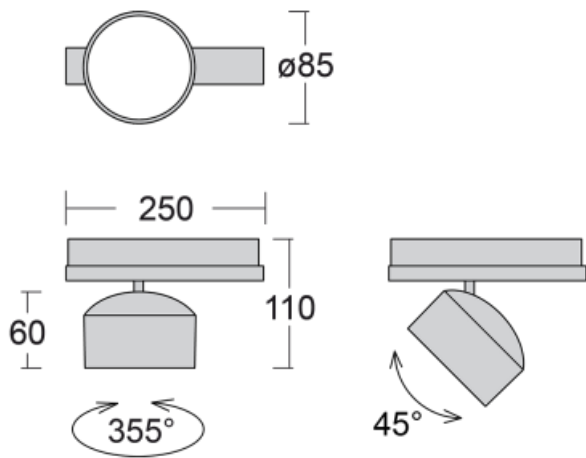

Family

Drob

Type of installation	3 circuit track
Light distribution	Direct
Colour of the luminaires	Black, Silver, White
Colour Temperature	3000 K warm white, 4000 K cool white
Material	Aluminium
Light source	LED MODUL
MacAdam Light source	3
Connection of the luminaires	ON/OFF DALI
Lifetime	L80/B20 50 000 hours
Warranty	60 months

Luminaire family variants Drob

Drob

Assembly

Light distribution

Energy class

A++, A+, A

Marks

Code	Dimensions l/w/h (mm)	Power of the luminaire (W)	Luminous flux (lm)	Colour Temperature (K)	UGR
177-600F-10GGE/940, W	ø 85 × 110	16.7	2000	4000	-
177-600F-10GGE/840, W	ø 85 × 110	16.7	2300	4000	-

The indicated codes stand for a white luminaire with colour temperature of 4000K and with a medium-wide beam angle.







Notes

Beam angle	21 - 63 °
Colour of the luminaires	● ● ●
Colour Temperature	3000 K warm white 4000 K cool white
Optic system	Reflector
Connection of the luminaires	ON/OFF DALI
Ra	80 90



Track luminaires come complete with adapters for Global Track from Nordic Aluminium.

Legend





Type of installation

 Recessed lights	 Wall mounted lights
 Semi-recessed luminaire	 Suspended lights
 Surface lights	 Free-standing lights
 3 circuit track lights	 Table lamp lights





Light distribution

 Direct luminaire
 Direct-indirect luminaire
 Indirect luminaire

Light source

 Tunable White adjusting the color temperature	 RealWhite true display of white color
 RealColour true display of colors Ra≥97	 StrongColour highlight one color

Marks

 Luminaire of electrical classification I (accessible conductive parts are connected to a protective cable)
 Luminaire of electrical classification II (accessible conductive parts are connected to a protective cable)
 Luminaire of electrical classification III (protection against electric shock is based on double or reinforced insulation)
 European mark of conformity that indicates the conformity of the properties of the product with all the harmonized standards and regulations of the European Community that apply to it
 Luminaires are certified according to the European ENEC system

 Recommended mounting hole size

IPxy IP code indicating the degree of protection of live parts

EARC Eurasian Conformity

09-501I-20GGE/840, W

09-501I-20GGE/840, W

09-501I-20GGE/840, W

09-501I-20GGE/840, W

Optic system

Electrical connection

Colour









Optic system

C Clear cover	L Plain aluminium reflector
D Asymmetric reflector	M Matt parabolic louvre
E Polished parabolic louvre, high LOR	S SPOT - narrow angle
F FLOOD - wide angle	U MEDIUM - middle angle
I Microprismatic optical system	W Wide beam angle
K Opal diffuser	

Electrical connection

D DALI dimmable	P Sensor and electronic ballast
E Electronic ballast non-dimmable	T By switch dimmable (touch dimm)
M Electronic ballast non-dimmable with 1h emergency	TD DALI or by switch (touch dimm) dimmable
M3 Electronic ballast non-dimmable with 3h emergency	U Dimmable luminaire with dimmer on the luminaire

Colour

W  White	B  Black	S  Silver
1021  RAL 1021	3000  RAL 3000	6021  RAL 6021
7006  RAL 7006	7045  RAL 7045	