



Family

Sant-S

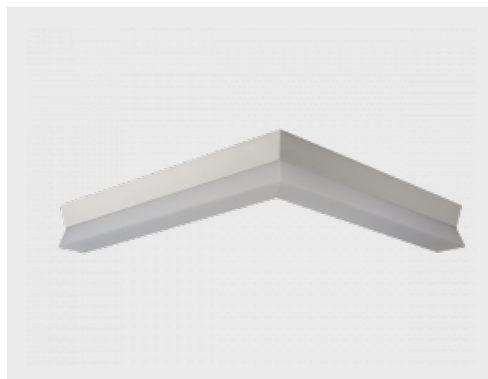
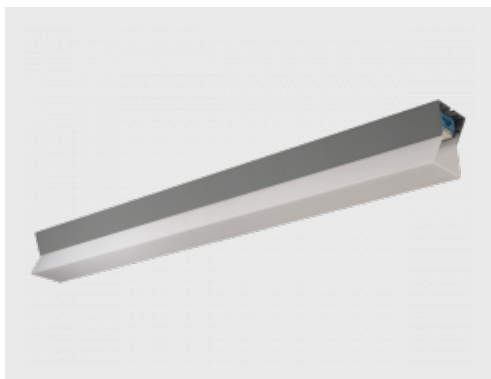

The Dutch designer Rob van Beek imbued this LED linear luminaire with an opal diffuser with a universal visage. In the Czech Republic, Sant-S was specially made for LED sources and Human Centric Lighting technology. In practice, it looks like the light changes intensity and color temperature according to biological rhythms. People thus feel natural in closed spaces, because the lighting simulates daylight. If you are looking for system linear lights for an office, school or hospital, you've just found it.

Type of installation	Surface, Wall mounted, Suspended
Light distribution	Direct-indirect
Colour of the luminaires	Black, Silver, White
Colour Temperature	3000 K warm white, 4000 K cool white, 2700 K - 6500 K Tunable White
Material	Aluminium
Light source	LED MODUL
LED type	Tunable White
MacAdam Light source	3
Connection of the luminaires	ON/OFF DALI ON/OFF + 1h emergency Other type of dimming ON/OFF + 3h emergency Tunable white
Lifetime	L80/B20 50 000 hours
Warranty	60 months

Luminaire family variants Sant-S

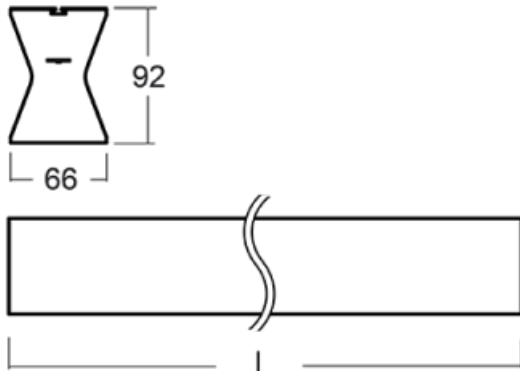
Sant-S

Assembly

Light distribution

Energy class

A++, A+, A

Marks





Code	Dimensions l/w/h (mm)	Power of the luminaire (W)	Luminous flux (lm)	Colour Temperature (K)	UGR
132-500K-10GEE/840, W	562 × 92 × 66	10.6	1060	4000	< 21.8
132-500K-10GGE/840, W	562 × 92 × 66	16.7	1690	4000	< 23.4
132-500K-15GEE/840, W	842 × 92 × 66	14.9	1530	4000	< 21.7
132-500K-15GGE/840, W	842 × 92 × 66	23.1	2380	4000	< 23.2
132-500K-20GEE/840, W	1122 × 92 × 66	21	2120	4000	< 21.8
132-500K-20GGE/840, W	1122 × 92 × 66	34.9	3560	4000	< 23.6
132-500K-25GEE/840, W	1402 × 92 × 66	27	2760	4000	< 22
132-500K-25GGE/840, W	1402 × 92 × 66	39.6	4120	4000	< 23.4
132-500K-30GEE/840, W	1682 × 92 × 66	31.5	3180	4000	< 21.9
132-500K-30GGE/840, W	1682 × 92 × 66	51.5	5290	4000	< 23.6
132-500K-35GEE/840, W	1962 × 92 × 66	36	3660	4000	< 21.8
132-500K-35GGE/840, W	1962 × 92 × 66	58	5970	4000	< 23.5
132-500K-40GEE/840, W	2242 × 92 × 66	42	4240	4000	< 21.9
132-500K-40GGE/840, W	2242 × 92 × 66	69.8	7130	4000	< 23.7

AnThese codes represent white luminaires with chromaticity temperature 4000K and opal diffuser.

Notes	Colour of the luminaires	
	Colour Temperature	3000 K warm white 4000 K cool white 2700 K - 6500 K Tunable White
	Optic system	Opal diffuser
	Connection of the luminaires	ON/OFF DALI ON/OFF + 1h emergency Other type of dimming ON/OFF + 3h emergency Tunable white
	Ra	80

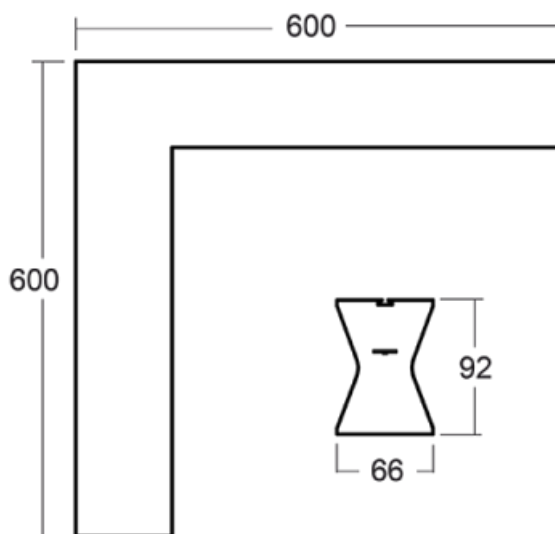
End caps, suspensions, supply cables, and ceiling cup for luminaires must be ordered separately. To connect into systems, please order the respective number of couplers.

Sant-S

	Assembly	Light distribution
		
	Energy class	Marks
A++, A+, A		

Code	Dimensions l/w/h (mm)	Power of the luminaire (W)	Luminous flux (lm)	Colour Temperature (K)	UGR
132-520K-20GEE/840, W	603 × 92 × 603	21	2120	4000	< 19.7
132-520K-20GGE/840, W	603 × 92 × 603	34.9	3560	4000	< 21.5

AnThese codes represent white luminaires with chromaticity temperature 4000K and opal diffuser.

Notes	Colour of the luminaires	
	Colour Temperature	3000 K warm white 4000 K cool white 2700 K - 6500 K Tunable White
	Optic system	Opal diffuser
	Connection of the luminaires	ON/OFF DALI Other type of dimming Tunable white
	Ra	80

End caps, suspensions, supply cables, and ceiling cup for luminaires must be ordered separately. To connect into systems, please order the respective number of couplers.

Accessories

Code	Description
00-00300, N	wire suspension 2000mm
00-00301, N	wire suspension 4000mm
00-00302, N	wire suspension 6000mm



Code	Description
00-00350, K	cable 3x0,75 1000mm
00-00351, K	cable 4x0,75 1000mm
00-00352, K	cable 3x0,75 2000mm
00-00353, K	cable 4x0,75 2000mm
00-00354, K	cable 5x0,75 1000mm
00-00355, K	cable 5x0,75 2000mm



Code	Description
00-00370, W	ceiling cup 80x80x32mm

Notes

Accessories colour



Code	Description
00-00600, F	ceiling fastening for luminaires 132-5xxK, 04-2000x, 05-2000x, 09-200x - 1 piece



Code	Description
00-51300, W	set for suspension into 3-phase track, non-dimmable luminaires

Notes

Accessories colour



Code

Description

00-51301, W

set for suspension into 3-phase track, dimmable luminaires

Notes

Accessories colour



Code

Description

132-50031, W

pendant profile 1000 mm

Notes

Accessories colour



Code

Description

132-50100, W

end cap

Notes

Accessories colour



Code

Description

132-50200, F

straight connector

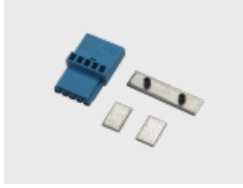









Code	Description
132-50201, F	straight connector (for dimmable lum.)





Code	Description
132-51100, K	diffuser 2295 mm

Legend





Type of installation

 Recessed lights	 Wall mounted lights
 Semi-recessed luminaire	 Suspended lights
 Surface lights	 Free-standing lights
 3 circuit track lights	 Table lamp lights





Light distribution

 Direct luminaire
 Direct-indirect luminaire
 Indirect luminaire

Light source

 Tunable White adjusting the color temperature	 RealWhite true display of white color
 RealColour true display of colors Ra≥97	 StrongColour highlight one color

Marks

 Luminaire of electrical classification I (accessible conductive parts are connected to a protective cable)
 Luminaire of electrical classification II (accessible conductive parts are connected to a protective cable)
 Luminaire of electrical classification III (protection against electric shock is based on double or reinforced insulation)
 European mark of conformity that indicates the conformity of the properties of the product with all the harmonized standards and regulations of the European Community that apply to it
 Luminaires are certified according to the European ENEC system

 Recommended mounting hole size

IPxy IP code indicating the degree of protection of live parts

ERC Eurasian Conformity

09-501I-20GGE/840, W

09-501I-20GGE/840, W

09-501I-20GGE/840, W

09-501I-20GGE/840, W

Optic system

Electrical connection

Colour









Optic system

C Clear cover	L Plain aluminium reflector
D Asymmetric reflector	M Matt parabolic louvre
E Polished parabolic louvre, high LOR	S SPOT - narrow angle
F FLOOD - wide angle	U MEDIUM - middle angle
I Microprismatic optical system	W Wide beam angle
K Opal diffuser	

Electrical connection

D DALI dimmable	P Sensor and electronic ballast
E Electronic ballast non-dimmable	T By switch dimmable (touch dimm)
M Electronic ballast non-dimmable with 1h emergency	TD DALI or by switch (touch dimm) dimmable
M3 Electronic ballast non-dimmable with 3h emergency	U Dimmable luminaire with dimmer on the luminaire

Colour

W  White	B  Black	S  Silver
1021  RAL 1021	3000  RAL 3000	6021  RAL 6021
7006  RAL 7006	7045  RAL 7045	